

# **B-Questa®**

**BIK®**  
Best Sound System from Japan

## **OWNER'S MANUAL** 使用说明书

# **BST-M108**

Portable Speaker System  
便携式扬声器系统

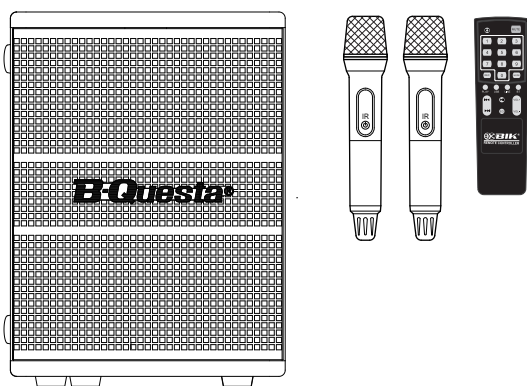

Thank you for purchasing our Portable Speaker System.

Please read the owner's manual thoroughly prior to using the system in order for you to make it use with safety and at the best function.

Please keep the manual for future reference.

感谢您购买本公司的便携式扬声器。



为了尽快地熟悉掌握本产品的各项功能，使用前请先阅读本说明书。

阅读完后，请注意妥善保管。



<b>CONTENTS</b>	CAUTION FOR SAFETY .....	2	BATTERY CHARGING AND	BASIC OPERATION .....	5
	FUNCTION AND NAME .....	3	EXTERNAL BATTERY	ANY TROUBLES ? .....	6
	CONNECTION .....	4	CONNECTION .....	SPECIFICATIONS .....	6





## CAUTION FOR SAFETY



This "Caution for safety" shows various kinds of pictures in order to be used safely and correctly and to prevent from damaging other people, and their property. Please read with full understanding, and carefulness.

 <b>WARNING</b>	This shows: Using this product with disregarding cautions might call for death or injury.
 <b>CAUTION</b>	This shows: Using this product with disregarding cautions might call for people to be harmed and goods to be damaged.

[ Examples of pictures show ]

-  △ Indicates cautions inclusive warnings.
-  ⊘ Indicators prohibition for action. Detail contents of prohibition are shown in the pictures (Pictures on left tells you not to re-assemble.)
-  ● Shows indication of full contents and action to be done. A concrete content (picture on left) tells :power supply plug to be taken out of outlet.

 <b>WARNING</b>	
<ul style="list-style-type: none"> <li>● Making use of this product under the circumstances that a smoke, an abnormal smell, an irregular sound come out, it may cause a fire and an electric shock. In this case, switch off the product, and take power supply plug out of the outlet right away. Bring it to the shop for repair.</li> <li>● In case when water or foreign substances get into product, switch off right away, and take power supply plug out of outlet, and consult with the repair shop, other wise, it may cause a fire or an electric shock.</li> <li>● In case when product is dropped, switch off right away, and take power supply plug out of outlet, and consult with the repair shop, otherwise, it may cause a fire or an electric shock.</li> </ul>	<p>WARNING</p>  <p>The power supply plug is pulled out from the outlet</p>
<ul style="list-style-type: none"> <li>● Re-assembling this product is highly prohibited, otherwise, it may cause a fire or an electric shock.</li> <li>● Do not take amplifier out, otherwise, it may cause an electric shock. Inspection, repair should be done in the repair shop.</li> </ul>	 <p>Decomposition prohibition</p>
<ul style="list-style-type: none"> <li>● This product can no way be used in the bathroom, otherwise, it may cause a fire, or an electric shock.</li> <li>● Pay attention not for water to go into or get wet. Or it may cause a fire or an electric shock.</li> </ul>	 <p>Use prohibition in water scene</p>
<ul style="list-style-type: none"> <li>● Do not use this product with a voltage other than indicated, or it may cause a fire, or an electric shock.</li> <li>● This product can be only used with AC power supply, which 220 - 240V 50Hz, or DC 12V power supply.</li> <li>● This product is not designed for built-in installation : do not place the product in an enclosed place such as a bookcase or rack.</li> <li>● Be careful for power supply plug, or outlet not to get dust or to get it wet, or it may cause a fire.</li> <li>● Do not put metal or flammable substances into this product, or it may cause a fire or an electric shock.</li> <li>● Do not put any containers with water, or small metal substances near or on this product, or it may cause a fire, or an electric shock, and it becomes out of order.</li> </ul>	 <p>PROHIBITION</p>

 <b>CAUTION</b>	
<ul style="list-style-type: none"> <li>● When this product is not used for a longer period, power supply plug should be taken out of outlet.</li> <li>● In case the thunder is generated near-by, take power supply plug out of outlet right away, or it may cause a fire or an electric shock.</li> <li>● If this product needs to be moved, switch off first, and then take power supply plug out, or it may damage cord, and may cause a fire or an electric shock.</li> </ul>	 <p>The power supply plug is pulled out from the outlet</p>
<ul style="list-style-type: none"> <li>● Do not put this product near cooking counter or damp supply outlet, or it may cause a fire or an electric shock.</li> <li>● Do not put this product on unstable desk, it may cause damage or injury when dropped.</li> <li>● Do not allow to come to heating equipment, or it may melt code surface and cause a fire or an electric shock.</li> <li>● Do not leave this product for a longer period such as in the cars where all windows are shut, or place where direct sunshine hits. Or it may damage each part of this product, and may cause a fire.</li> <li>● Do not plug in or plug out with wet hands, or it may cause an electric shock.</li> <li>● When taking power supply plug out, do not pull out cord, or it may damage cord, and cause a fire or an electric shock. Grip plug itself when taking out of outlet.</li> <li>● If the built-in battery is fully charged and the battery life is significantly reduced, it is time to replace the battery. Contact the repair shop before replacing the battery.</li> </ul>	 <p>CAUTION</p>

## FUNCTION AND NAME

### Amplifier operational panel

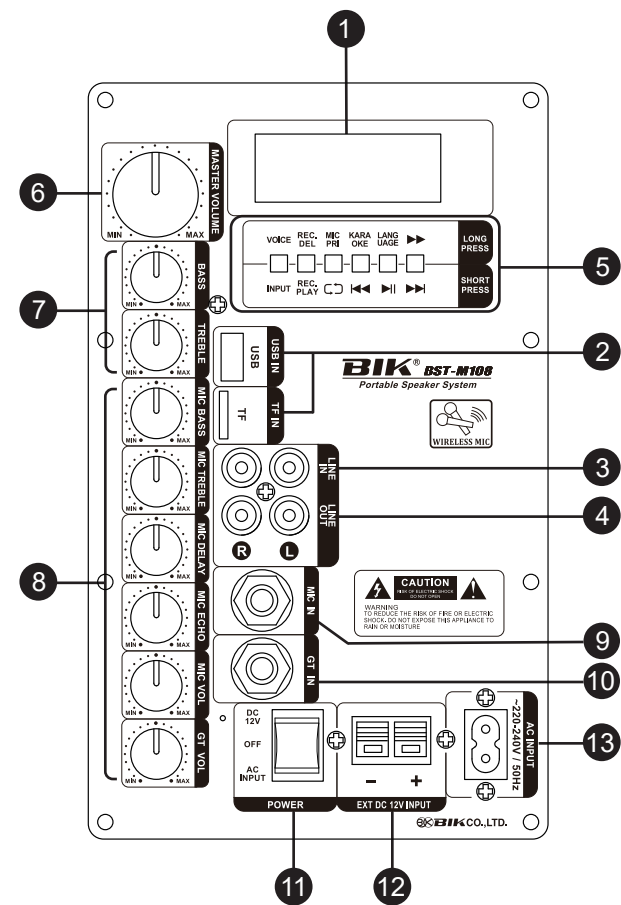

**1 DISPLAY**  
To show the operate mode.

**2 USB / TF port**  
To insert USB / TF CARD.

**3 LINE IN**  
Audio input.

**4 LINE OUT**  
Audio output.

**5 CONTROL BUTTONS**  
**SHORT PRESS**

INPUT : To select the input in the order of BLUE, LINE, USB, CARD. When the BT connection is completed, the blinking "BLUE" display changes to lit.  
(BT device name of this product is "BST-M108")

REC.PLAY : To record of MIC input , and to play the recorded content of USB or TF card.

☺ : To switch the repeate of one or all songs.

◀◀ : Reverse

▶▶ : Pause, Play.

▶▶▶ : Forward

**LONG PRESS**

VOICE : To make Voice or not.

REC. DEL : To delete recording.

MIC PRI : To reduce other music, when MIC voice is input.

KARAOKE : To set to KARAOKE mode.

LANGUAGE : To select chinese or english.

▶▶▶▶ : Fast Forward.

**6 MASTER VOLUME**  
To adjust Music volume. (From "U00" to "U32" )

**7 Music Tone Control Volumes**  
To adjust Tone of Bass and Treble.  
(From "b-09" to "b09", from "Γ-09" to "Γ 09" )

**8 8-1. MIC Tone Control Volumes**  
To adjust Tone of Bass and Treble of the MIC.  
(From "b-09" to "b09", from "Γ-09" to "Γ 09" )

**8-2. MIC DELAY**  
To adjust the Delay time of Echo of the MIC.  
(From "Cd00" to "Cd10")

**8-3. MIC ECHO**  
To adjust the level of Echo of the MIC.  
(From "EC00" to "EC10" )

**8-4. MIC VOL**  
To adjust the level of the MIC. (From "CU00" to "CU16" )

**8-5. GT VOL**  
To adjust the Guitar volume. (From "gΓ00" to "gΓ10" )

**9 MIC IN**  
MIC input.

**10 GT IN**  
Guitar input.

**11 POWER Switch**  
OFF : Power OFF  
DC 12V : To drive by Battery power.  
AC INPUT : To drive by AC power.

**12 EXT DC 12V INPUT**  
External battery input DC12V.

**13 AC INPUT**  
Power input AC220 - 240V / 50Hz.

## REMOTE CONTROLLER

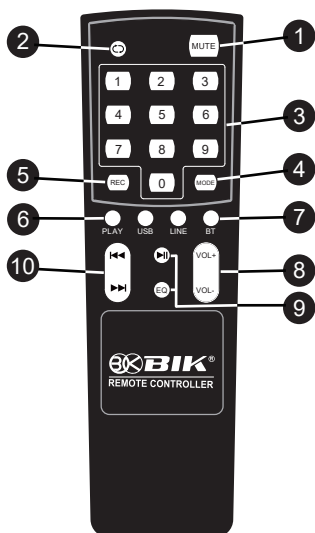

- ① **MUTE Button**
- ② **Repeat Button** : To select ONE or ALL repeat. To reduce other music, when MIC voice is input. (Push the "Repeat" button for more than 2 second.)
- ③ **Select track Button** : Select the track number directly with numbers. (For USB and TF CARD only.)
- ④ **MODE Button** : To select input BLUETOOTH, LINE, USB, or TF CARD. To make Voice or not. (Push the "MODE" button for more than 2 second.)
- ⑤ **REC Button** : Recording or to play recorded contents.
- ⑥ **PLAY Button** : To play recorded contents. For deleting recorded contents, push the "PLAY" button for more than 2 seconds.
- ⑦ **USB, LINE, BT Button** : To select USB, LINE, or BLUETOOTH directly.
- ⑧ **VOL +, VOL - Button** : To adjust music volume.
- ⑨ **Pause Button** : To pause BLUETOOTH, USB, or TF CARD. To select Chinese or English. (Push the "▶||" button for more than 2 second.)
- EQ Button** : To select POP, ROCK, JASS, CLASSIC, or FLAT.
- ⑩ **Reverse Forward Button** : "◀◀" Reverse. "▶▶" Forward.

## WIRELESS MICROPHONE

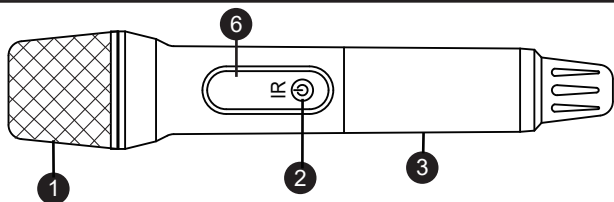

- ① Microphone head case
- ② Power Switch / Channel setting / Level setting
- ③ Grip
- ④ Battery case for Lithium ion battery (18650).
- ⑤ AA battery case.
- ⑥ Display

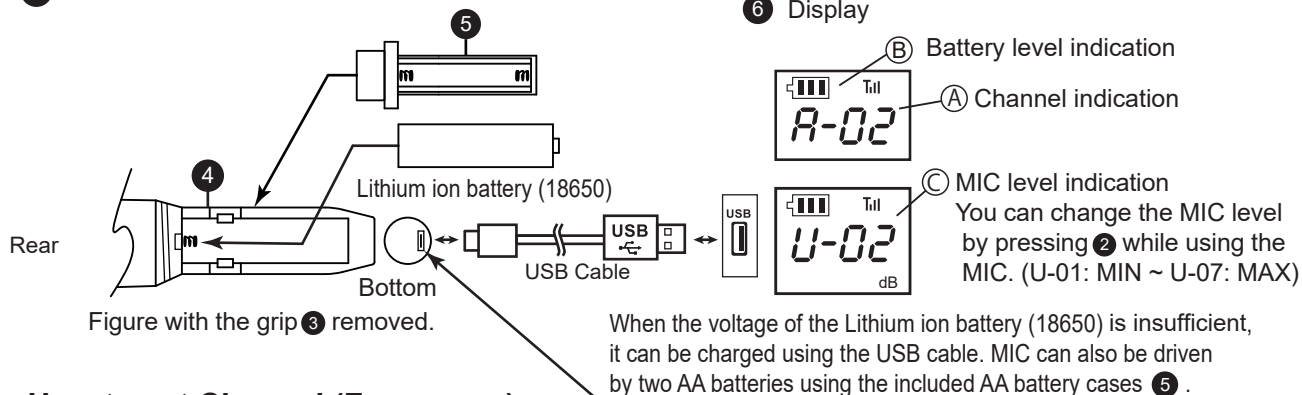

### ● How to set Channel (Frequency)

1. Put a microphone to near the amplifier panel.
2. With MIC OFF, press and hold ② (about 5 seconds) to display "SEL".
3. You can change the channel by pressing ② after displaying "SEL".

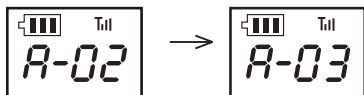

MIC A: 01 - 50 CH  
MIC B: 51 - 100 CH

4. Automatically connects wirelessly with Amplifier after selecting a channel.

## CONNECTION

1. How to connect to Audio output of music source.

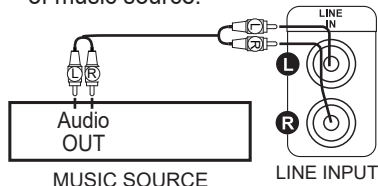

2. How to connect to Audio input of amplifier.

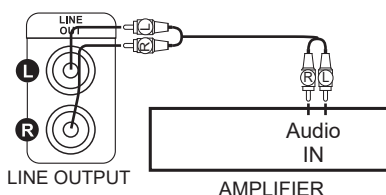

3. How to connect to Guitar and Microphones.

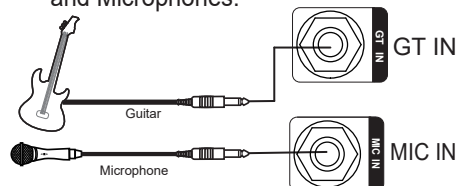

### (IMPORTANT)

Do not turn on the power until all connections are completed. When turning on the power, turn on the power of the external Amplifier last. When turning off the power, turn off the power of the external Amplifier first.

## BATTERY CHARGING AND EXTERNAL BATTERY CONNECTION

Please fully charge the battery before using this product for the first time.

### 1. How to charge the built-in battery.

When you connect this product to an “AC OUTLET” with a “Power Cable” , the "CHARGE" LED (BLUE) lights up and charging starts.

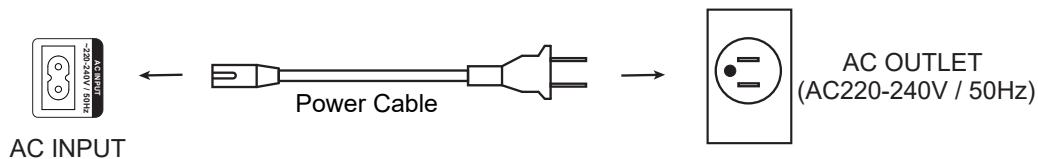

In "CHARGING" this LED (BLUE) lights up.

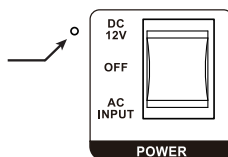

### 2. How to connect an external battery.

You can connect an external battery of DC12V to drive this product.  
(See the figure below)

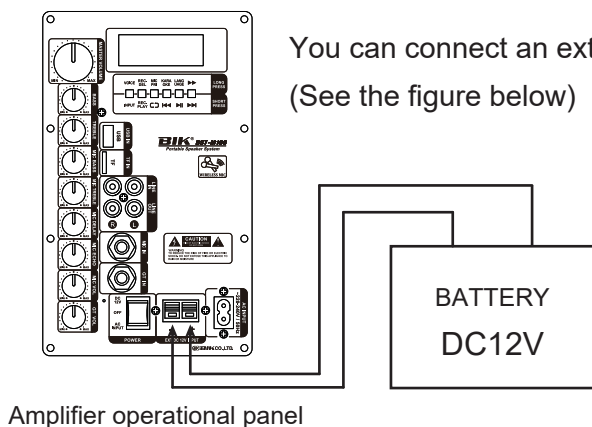

## BASIC OPERATION

1. Connect this product **13** to an “AC OUTLET” with a “Power Cable”.
2. POWER Switch **11** ON.
3. Press the INPUT button **5** to select input.
4. Adjust “MASTER VOLUME” knob **6** at your required volume.

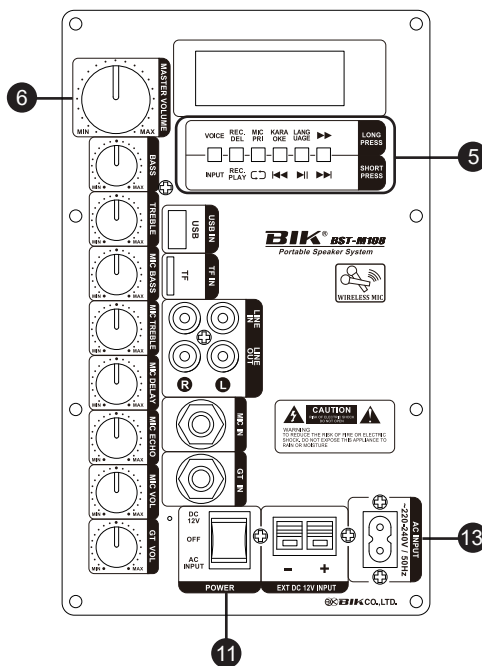

## ANY TROUBLES?

Any troubles? Please check the followings. Your careless mistakes seem to be troubles. Consult with your dealers in case any troubles can not be solved after checking the followings.

Trouble	Cause	Remedy
Not turned on	<ul style="list-style-type: none"> <li>● Not plugged in</li> <li>● Battery voltage drop</li> </ul>	<ul style="list-style-type: none"> <li>● Plug cord in</li> <li>● Charge Battery</li> </ul>
No sound produced even music starts in "On position"	<ul style="list-style-type: none"> <li>● Volume is set at minimum position</li> <li>● Input signal wires in poor or not connected correctly</li> </ul>	<ul style="list-style-type: none"> <li>● Set volume at your required position</li> <li>● Re-connect once again</li> </ul>
Noisy	<ul style="list-style-type: none"> <li>● Battery voltage drop</li> </ul>	<ul style="list-style-type: none"> <li>● Plug in the power cable</li> </ul>

## SPECIFICATIONS

### Amplifier

Maximum Output Power .....	44W / 4Ω
Frequency Response .....	20Hz - 20kHz
LINE INPUT .....	200mV
MIC INPUT .....	20mV
GUITAR INPUT .....	20mV
AUDIO OUTPUT .....	5V
BATTERY Part Number .....	6FM4.5 (12V4.5Ah / 20Hr)

### Speaker

Woofer .....	200mm Cone Type
Tweeter .....	77mm Cone Type

### Wireless Microphone

Voltage ....	DC3.7V - 4.2V (Lithium ion battery 1 piece)
Operating current .....	80mA (MIN)
Continuous use time .....	About 8 -10H (Depends on battery capacity)
Frequency .....	UHF Frequency conversion / 740.3 - 805.3MHz
Channel .....	MIC A : 740.3 - 755.3MHz (01 - 50CH) MIC B : 790.3 - 805.3MHz (51 - 100CH)
Dynamic range .....	105 dB (MIN)
Frequency response .....	40Hz - 15kHz
Microphone Type .....	Dynamic Type / Unidirectional

### Power Supply, Others

Power Voltage .....	AC220 - 240V / 50Hz DC 12V
Power Consumption .....	17 W
Dimensions (W x H x D) .....	264 x 350 x 244 mm
Weight .....	8.0 Kg

### Accessories

Owner's manual .....	1
Power Cable .....	1
Remote Controller .....	1
Wireless Microphone .....	(MIC A, MIC B) 2
USB Cable .....	2
AA battery case (For MIC A, MIC B) .....	2

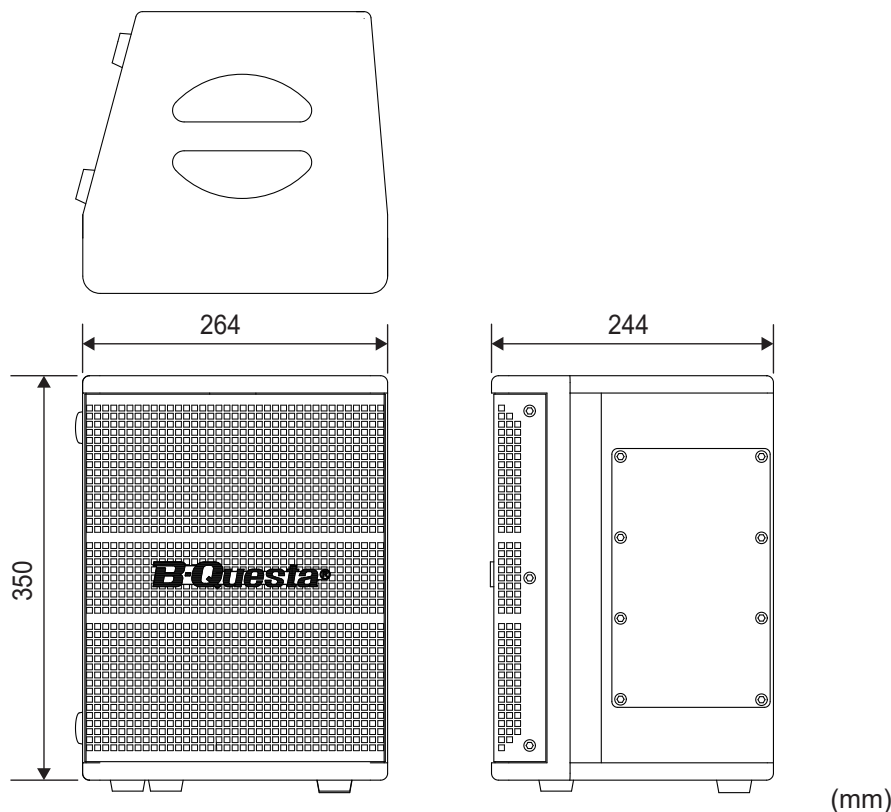

● Design and specifications subject to change without notice.



目录	安全注意事项 .....	7	电池充电及外接电池连接方法 .....	10	产品规格 .....	11
	各部分的功能及名称 .....	8	操作方法 .....	10		
	各外接部分的连接方法 .....	9	故障分析处理 .....	11		

## 安全注意事项

安全注意事项是为了安全正确使用本商品，防止给自己及他人带来财产损失。  
以下用图标的形式加以注明。请仔细阅读本文。

 <b>警告</b>	无视或误用会有造成人身事故的可能性。
 <b>注意</b>	无视或误用会有造成人身伤残，财产损失的可能性。

[图标表示的说明]



△记号是表示注意（包括警告）的内容。







⊘记号是表示禁止内容。



具体的禁止内容注明在图标中（例：左图是表示禁止分解）。



●记号是表示强制行为。

具体的指示内容注明在图标中（例：左图是表示拔下电源插头）。

 <b>警告</b>	
<ul style="list-style-type: none"> <li>● 在使用时，如果有冒烟、异味、异音等异常现象发生，为避免发生火灾，触电现象等，请立即切断本机电源，然后拔下电源插头。确认没有再冒烟后，到贩卖店进行修理。</li> <li>● 在使用时如有水或异物等混入机体内，首先切断机体电源，然后拔下电源插头。请尽快与贩卖店联系进行修理。在未进行维修的状态下使用，会引起火灾，触电等问题。</li> <li>● 在使用时如不慎掉落在地上造成损坏时，首先切断机体电源，然后拔下电源插头。请尽快与贩卖店联系进行修理。在未进行维修的状态下使用，会引起火灾，触电等事故。</li> </ul>	<p>警告</p>  <p>从插座上拔下电源插头</p>
<ul style="list-style-type: none"> <li>● 请勿分解、改装本机器。会引起火灾、触电、故障等事故。</li> <li>● 绝对禁止私自拆解功率放大器，以免造成触电等事故。检测、修理等请交由贩卖店进行处理。</li> </ul>	 <p>分解 禁止</p>
<ul style="list-style-type: none"> <li>● 请防止机器进水或使机器受潮，会引起火灾、触电等事故。</li> </ul>	 <p>潮湿场所 禁止使用</p>
<ul style="list-style-type: none"> <li>● 请勿使用指定以外的电源电压。会引起火灾，触电等事故。</li> <li>● 本机器的电源电压使用范围AC220V - 240V，或DC12V。</li> <li>● 本产品的的设计是采用风扇强制排风散热，请勿将机器放置于密闭环境或不通风的地方。</li> <li>● 请不要用带有灰尘，潮湿的插头和插座，会引起火灾等事故。</li> <li>● 请注意不要将金属物品、或易燃物品插入机器中，以免引起火灾、触电等事故。</li> <li>● 请不要在机器上或附近放置装有液体的容器及金属物。</li> </ul>	 <p>禁止</p>

 <b>注意</b>	
<ul style="list-style-type: none"> <li>● 旅行等长时间不使用时，为了安全请务必拔下电源插头。</li> <li>● 如近距离内有雷电现象时，请拔下电源插头，由于雷电原因，会引起火灾、触电、故障等事故。</li> <li>● 移动时，首先切断电源，然后务必拔下电源插头，再拆下其他接线。如电源线有损坏，会引起火灾、触电等事故。</li> </ul>	 <p>从插座上拔下电源插头</p>
<ul style="list-style-type: none"> <li>● 请勿放置在灶台、加湿器及有油烟、雾气的地方。会引起火灾、触电等事故。</li> <li>● 请勿放置在不安稳的桌上、或倾斜的地方。会容易掉落、翻倒而造成损坏、损伤。</li> <li>● 请避免将电源线靠近过热的物品，以免电源线被熔化，而引起火灾、触电等事故。</li> <li>● 请勿放置在紧闭车窗的汽车内、或阳光直射及高温的地方。以免造成零部件的损坏，而引起火灾。</li> <li>● 请勿放置在潮湿、多灰尘的地方。以免引起火灾、触电等事故。</li> <li>● 请不要用潮湿的手拔、插电源插头。以免引起触电事故。</li> <li>● 为了防止因电源线的损坏而引起火灾、触电等事故。在拔电源插头时，请务必握住电源插头后再拔下。</li> <li>● 如果内置电池的续航时间明显缩短的话，说明快到电池的使用寿命，应联系贩卖店更换电池。</li> </ul>	 <p>注意</p>

## 各部分的功能及名称

### 功放操作面板

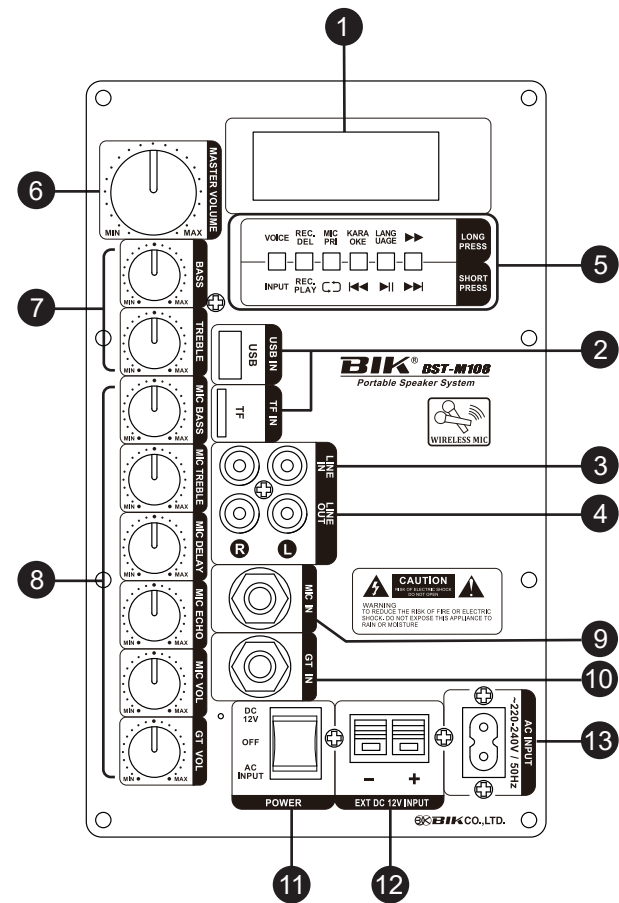

① 显示屏  
显示实时操作状态

② USB/ TF储存卡端子

③ 音频信号输入端子

④ 音频信号输出端子

⑤ 各功能操作按键

短按按键/SHORT PRESS

INPUT: 切换输入信号(蓝牙, 音频信号, U盘, 储存卡)  
蓝牙连接成功后, 蓝牙显示不再闪烁。  
(本产品的蓝牙设备名称为“BST-M108”)

REC.PLAY: 录音(只收录话筒的声音), 需插入USB / TF  
储存卡。再按一次, 播放收录在  
U盘/储存卡的录音。

☺ : “ONE” 表示单曲循环。“ALL” 表示顺序循环。

⏮ : 上一首

⏸ : 暂停, 再按一次播放。

⏭ : 下一首

长按按键/LONG PRESS

VOICE : 开启/关闭 语音提示

REC. DEL : 删除录制在USB / TF储存卡的录音内容。

MIC PRI : 麦克风优先按键

(开启后/ON, 使用麦克风时背景音量变小)

Karaoke : K歌模式

LANGUAGE : 切换中文/英文 语音提示

▶▶ : 快进

⑥ 主音量旋钮

⑦ 音乐音调控制旋钮 (调整音乐低音和高音电平)

⑧ 8-1. 麦克风音调控制旋钮 (调整麦克风低音和高音电平)

8-2. 麦克风延迟旋钮 (调整麦克风延迟时间)

8-3. 麦克风混响旋钮 (调节麦克风的混响大小)

8-4. 麦克风音量旋钮 (调节麦克风声音大小)

8-5. 吉他音量旋钮 (调节吉他音量)

⑨ 麦克风输入接口

⑩ 吉他接口 (吉他信号输入接口)

⑪ 电源开关

OFF : 关机

DC 12V : 电池电源启动

AC INPUT : AC电源启动

⑫ 外部电池接口 (直流12V)

⑬ AC电源输入接口 (AC220V to AC240V / 50Hz)



## 遥控器

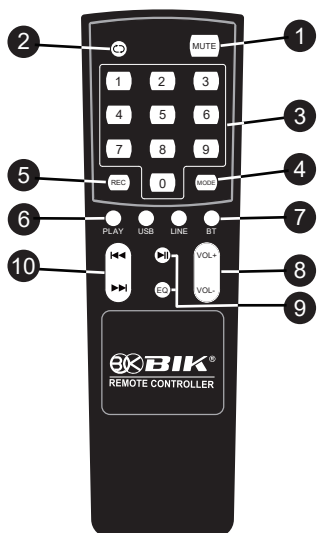

- ① 静音
- ② 循环播放  $\curvearrowright$  : 可选择单曲循环或顺序播放。长按2秒以上进入麦克风声音优先模式, 背景音乐音量会自动降低。
- ③ 选择歌曲: 输入U盘和储存卡中歌曲的对应顺序进行播放。
- ④ 音源信号选择: 选择输入的音源信号。(可切换蓝牙, LINE, USB, 储存卡)  
长按2秒以上可开启/关闭换语音提示。
- ⑤ 录音: 只收录话筒的声音。再按一次, 播放存储在U盘/储存卡的录音。
- ⑥ 播放录音: 短按播放录音。长按2秒以上删除录音。
- ⑦ 切换USB, LINE, 蓝牙的输入信号
- ⑧ 调整音量
- ⑨ 暂停  $\text{||}$  : 暂停蓝牙, USB, 或者储存卡的音乐。  
切换提示语言: 中文/英文 (长按 “ $\text{||}$ ” 按键2秒以上)  
切换效果: 可以选择POP (流行), ROCK (摇滚), JASS (爵士)  
CLASSIC (经典) FLAT (原声)。
- ⑩ 上一曲/下一曲:  
 $\text{◀}$  上一曲  $\text{▶}$  下一曲

## 无线麦克风

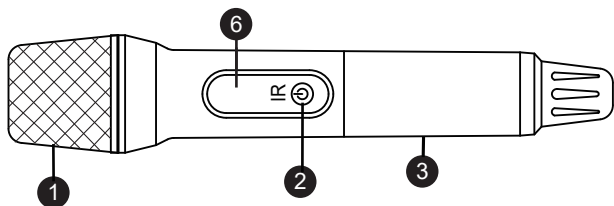

- ① 网头和音头模组
- ② 电源开关/频道设置/音量设置
- ③ 麦克风管体
- ④ 电池仓
- ⑤ AA电池盒
- ⑥ 显示屏

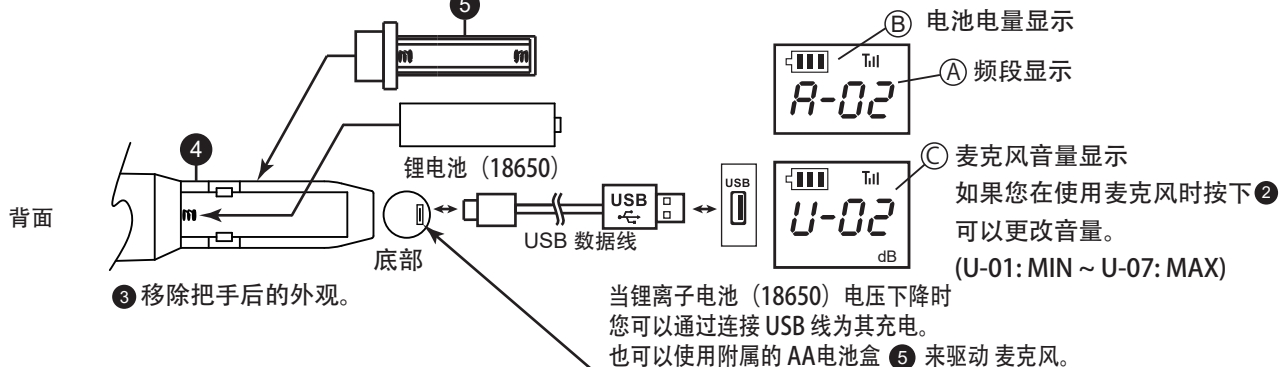

### ● 如何设置频道 (频率)

1. 将麦克风放在功放控制面板附近。
2. 先关闭麦克风再按住②约5秒钟, 将显示“SEL”。
3. 您可以在显示“SEL”后按②更改频道。



4. 完成频道设置后, 麦克风的无线连接自动完成。

## 各外接部分的连接方法

### 1. 如何连接音源信号

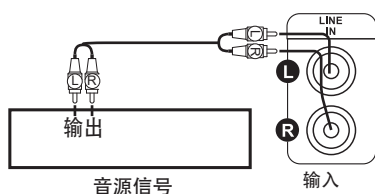

### 2. 如何将音频输出信号连接到外接功放

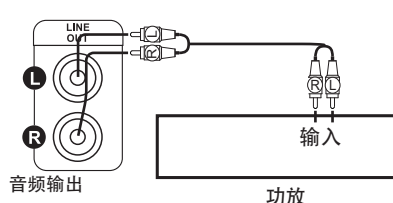

### 3. 如何连接吉他和麦克风

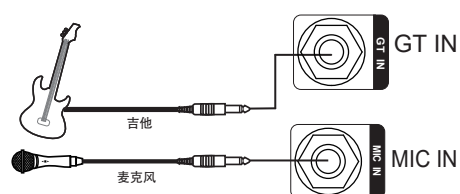

### (重要)

在所有连接完成之前不要打开电源。当打开电源时, 最后再打开外接功放的电源。  
关闭电源时, 请先关闭外接功放的电源。

## 电池充电及外接电池连接方法

首次使用本产品前，请将电池充满电后再使用。

### 1. 电池充电方法

电源输入接口连接电源后，充电开始。

此时，充电 LED（红色）亮起。（见下图）

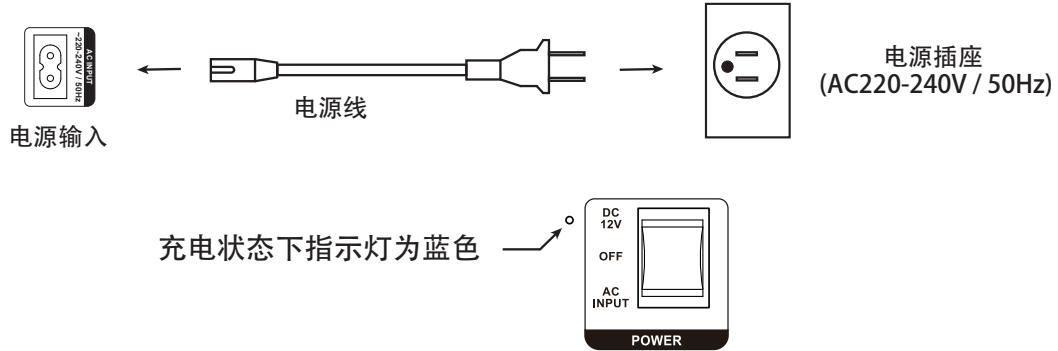

### 2. 外接电池连接方法

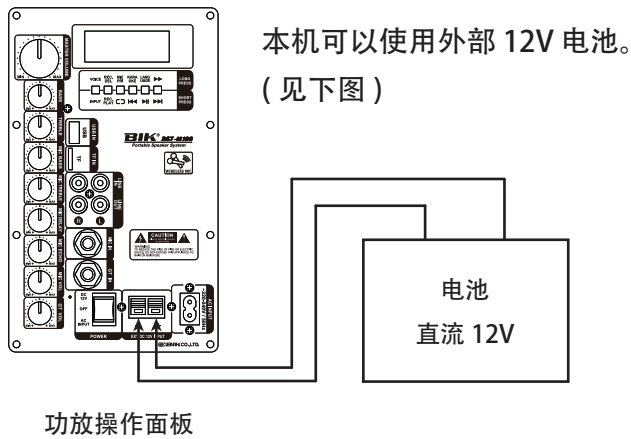

## 操作方法

1. 用附带的电源线将“AC INPUT”<sup>⑬</sup>和“电源插座”连接。
2. 打开电源开关<sup>⑪</sup>。
3. 按<sup>⑤</sup>“INPUT”（输入信号）选择输入信号。
4. 旋转“主音量旋钮”<sup>⑥</sup>来调节音量。

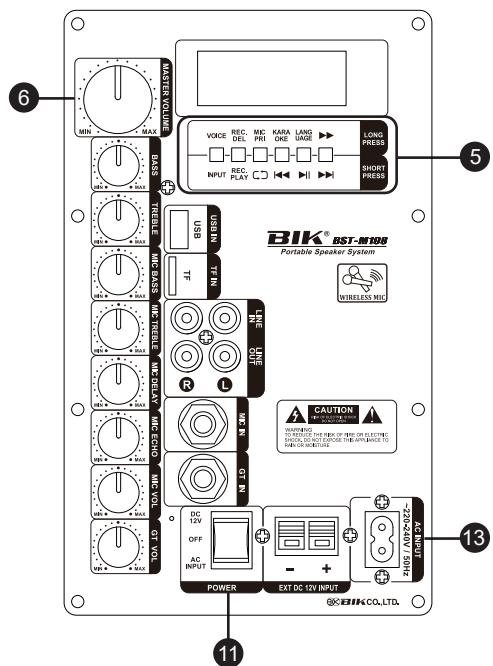

## 故障分析处理

如发现有故障请根据以下方法检查。偶尔会有因为操作错误而误认为是故障的现象。根据以下方法检查也不能解决的情况下，请直接联系贩卖店。

症状	原因	处理
不通电	● 没有插入电源或电池电量不足	● 插入电源线/充电
通电后有音乐信号输入但是没有声音	● 音量旋钮没有打开 ● 输入信号连接线不良或者没有连接好	● 调节适当的音量位置 ● 检查连接线，重新连接
出现杂音	● 电池电量过低	● 插入电源线/充电

## 产品规格

### 功能放大器部分

最大输出	44W / 4Ω
频率特性	20Hz - 20kHz
音乐输入灵敏度	200mV
麦克风输入灵敏度	20mV
吉他输入灵敏度	20mV
前级输出	5V
电池型号	6FM4.5 (12V4.5Ah / 20Hr)

### 扬声器部分

低音单元	200mm 圆锥形
高音单元	77mm 圆锥形

### 无线麦克风

电源工作电压	DC3.7V - 4.2V (一节18650锂电池)
工作电流	> 80mA
连续使用时间	约8 - 10小时 (根据电池容量来定)
频率	U段变频: 740.3 - 805.3MHz
通道	MIC A: 740.3 - 755.3MHz (01 - 50CH) MIC B: 790.3 - 805.3MHz (51 - 100CH)

动态范围	> 105 dB
频率响应	40Hz - 15kHz
拾音器	动圈式 / 单指向性

### 电源及其他

电源电压	AC220 - 240V / 50Hz DC 12V
------	-------------------------------

电源功耗	17W
外形尺寸 (长 x 宽 x 高)	264 x 244 x 350 mm
净重	8.0 Kg

### 附属品

使用说明书	1个
电源适配器	1个
遥控器	1个
无线麦克风	(MIC A, MIC B) 2个
USB 数据线	2个
电池盒(MIC A, MIC B用)	2个

● 为了改善产品而改变上述规格和外观时，本公司将不予另行通告。

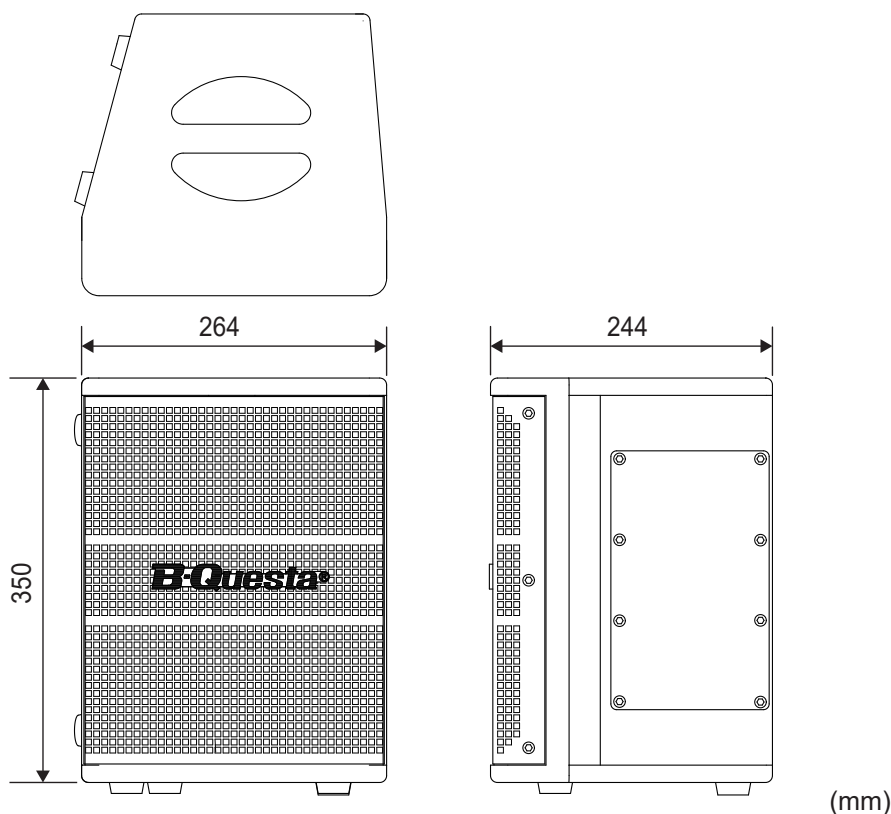



---

株式会社 ビーアイケー  
〒343-0856 埼玉県越谷市谷中町3丁目17-1

**BIK CO.,LTD.**  
3-17-1 YANAKA-CHO. KOSHIGAYA-SHI. SAITAMA-KEN. 343-0856 JAPAN  
TEL. +81-48-969-6533 FAX. +81-48-969-6556  
URL. <http://www.bik-audio.com> Email. [best-sound@bik-coltd.jp](mailto:best-sound@bik-coltd.jp)