



Best Sound System from Japan

# OWNER'S MANUAL

## 使用说明书

# BJ-U100

UHF WIRELESS MICROPHONE SYSTEM

UHF无线麦克风系统

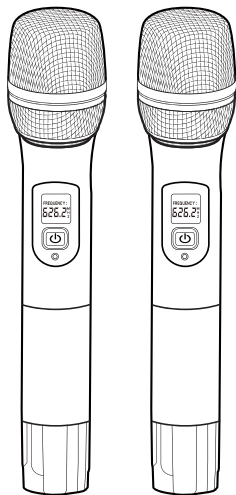
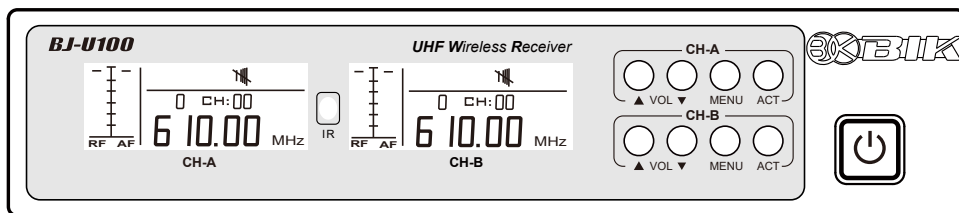

**BJ-M100**

Thank you for purchasing our UHF WIRELESS MICROPHONE SYSTEM.

Please read the owner's manual thoroughly prior to use.

Please keep the manual for future reference.

感谢您购买本公司的UHF无线麦克风系统。



为了尽快的熟悉掌握本产品的各项功能，使用前请仔细阅读本说明书。

阅读后，请注意妥善保管。

<b>CONTENTS</b>	CAUTION FOR SAFETY..... 2	BASIC OPERATION ..... 3	SPECIFICATIONS ..... 4
	FUNCTION AND NAME ..... 2	HOW TO SET ..... 3	
	CONNECTION ..... 3	ANY TROUBLES ? ..... 4	

## CAUTION FOR SAFETY

This "Caution for safety" shows various kinds of pictures in order to be used safely and correctly and to prevent from damaging other people, and their property. Please read with full understanding, and carefulness.

 <b>WARNING</b>	This shows: Using this product with disregarding cautions might call for death or injury.
 <b>CAUTION</b>	This shows: Using this product with disregarding cautions might call for people to be harmed and goods to be damaged.

### WARNING

- Making use of this product under the circumstances that a smoke, an abnormal smell, an irregular sound come out, it may cause a fire and an electric shock. In this case, switch off the product, and take AC adapter plug out of the outlet right away. Bring it to the shop for repair.
- In case when water or foreign substances get into product, switch off right away, and take AC adapter plug out of outlet, and consult with the repair shop, otherwise, it may cause a fire or an electric shock.
- Re-assembling this product is highly prohibited, otherwise, it may cause a fire or an electric shock.
- Do not take the cover out, otherwise, it may cause an electric shock. Inspection, repair should be done in the repair shop.
- This product can no way be used in the bathroom, otherwise, it may cause a fire, or an electric shock.
- Pay attention not for water to go into or get wet. Or it may cause a fire or an electric shock.
- AC adapters can be used only with AC100V-240V, otherwise it may cause fire or receive an electric shock.
- Be sure to make a use of adapters supplied, using other adapters may cause equipments out of use.
- This product is not designed for built-in installation : do not place the product in an enclosed place such as a bookcase or rack.
- Be careful for AC adapter plug, or outlet not to get dust or to get wet, or it may cause a fire.

### CAUTION

- When this product is not used for a longer period, power supply plug should be taken out of outlet.
- In case the thunder is generated near-by, take power supply plug out of outlet right away, or it may cause a fire or an electric shock.
- If this product needs to be moved, switch off first, and then take power supply plug out, or it may damage cord, and may cause a fire or an electric shock.
- Do not put this product near cooking counter or damp supply outlet, or it may cause a fire or an electric shock.
- Do not put this product on unstable desk, it may cause damage or injury when dropped.
- Do not leave this product for a longer period such as in the cars where all windows are shut, or place where direct sunshine hits, or it may damage each part of this product, and may cause a fire.

## FUNCTION AND NAME

### FRONT PANEL

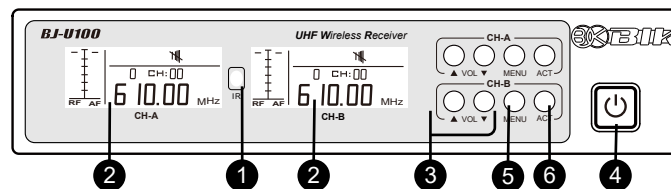

- 1 Infrared communication "IR"**  
Channel can be automatically set by communication with microphones and receiver.
- 2 Screen indication**
- 3 VOL button**  
Adjusting volume, adjusting channel.
- 4 Power Switch**
- 5 Menu button**  
Pushing "MENU" button for a 3 seconds. Set a channel with pushing "▲" or "▼" VOL button. Pushing "MENU" button for a 3 seconds, It is locked.
- 6 ACT button**  
Pushing ACT button, it is connected with microphone automatically.

### REAR PANEL

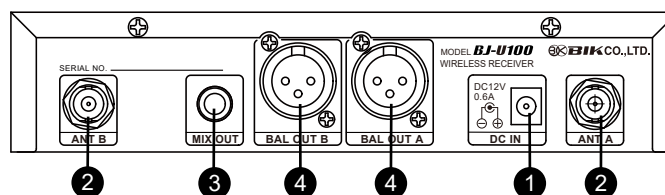

- 1 Terminal for DC12V power supply**  
Connected with supplied AC adapter plug.
- 2 Antenna terminal**  
Connected with antenna supplied.
- 3 MIX output terminal.**  
Output terminal for mixing MIC A with MIC B.
- 4 Output terminal (Balance output).**

## MICROPHONE

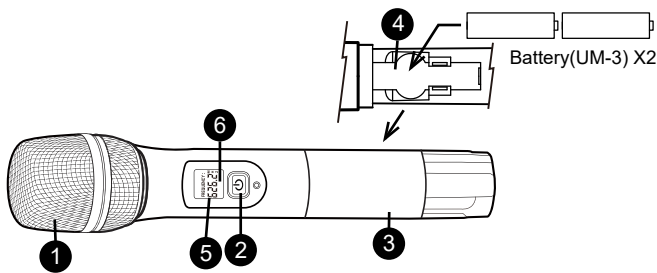

- ① Microphone head case
- ② Switch
- ③ Grip
- ④ Battery case for UM-3 x 2
- ⑤ Indication screen
- ⑥ Infrared communication "IR"

## CONNECTION

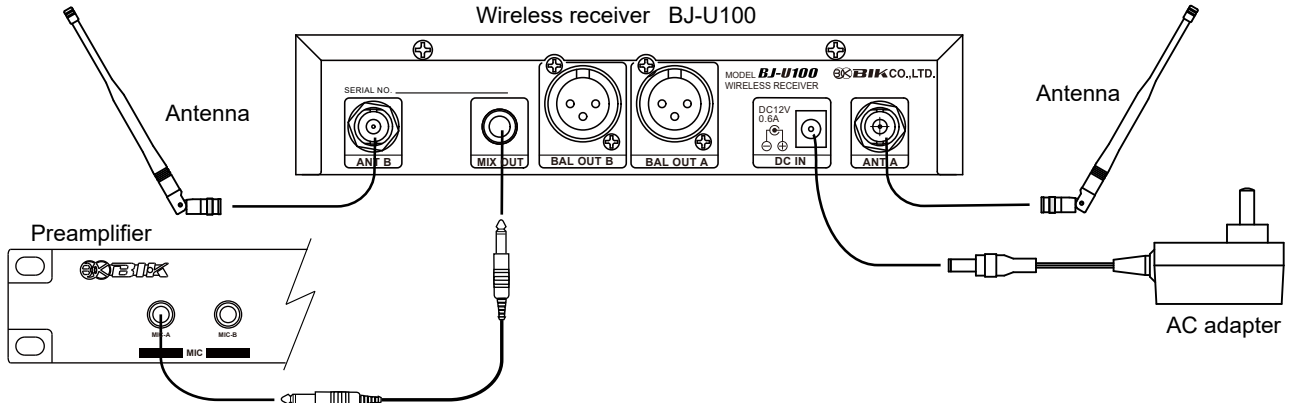

## BASIC OPERATION

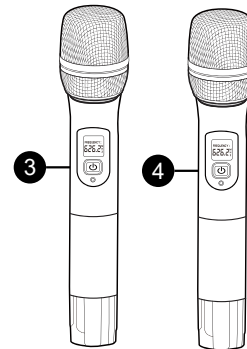
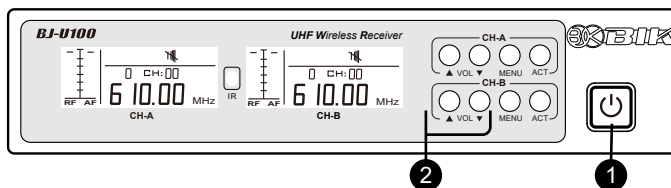

1. Set "off" position of microphone switch ③ and ④.
2. To set "On", push receiver power switch ①.
3. To set microphone switch "On".
4. To adjust volume ②.

### ※ Caution

A channel of a receiver and a microphone are set at the factory. When a RF signal showed to a screen at the power switch ON of receiver, there is interfering signal in the neighborhood. Please change the channel to other channels. (Please refer to "How to set the channel" )

## HOW TO SET

### How to set the channel (Frequency)

Pushing "MENU" button for a 3 seconds.  
Set a channel with pushing "▲" or "▼" VOL button.  
Pushing "MENU" button for a 3 seconds, It is locked.

### How to set microphone.

Set microphone switch "On", then direct "IR" in infrared window "IR" infrared window of receiver.  
Push "ACT" button.  
A microphone channel (frequency) is automatically set.

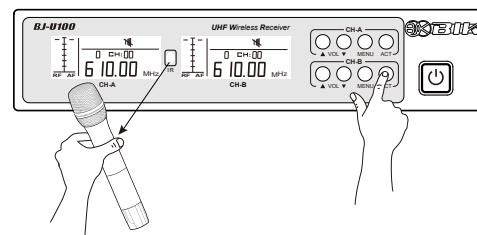

## ANY TROUBLES ?

Any troubles? please check the followings. Your careless mistakes seem to be troubles.  
Consult with your dealers in case any troubles can not be solved after checking the followings.

Trouble	Cause	Remedy
Can not power switch on	<ul style="list-style-type: none"> <li>● AC adapter is not plugged in an outlet.</li> <li>● AC adapter plug (DC 12V) is not connected to Receiver.</li> </ul>	<ul style="list-style-type: none"> <li>● Plug in an outlet.</li> <li>● Connect AC adapter plug(DC12V) to Receiver.</li> </ul>
Microphone can not switch on	<ul style="list-style-type: none"> <li>● Batteries gone</li> </ul>	<ul style="list-style-type: none"> <li>● Change batteries.</li> </ul>
No sound	<ul style="list-style-type: none"> <li>● Receiver is correctly connected to other equipments?</li> <li>● Receiver volume is set " Minimum " position?</li> <li>● Volume of other equipments connected is set at " Minimum " position?</li> <li>● Setting receiver channel is same with that of microphone?</li> </ul>	<ul style="list-style-type: none"> <li>● Check connection again.</li> <li>● Turn up Receiver volume.</li> <li>● Turn up other equipments volume.</li> <li>● Re-set channels.</li> </ul>
Sound distortion	<ul style="list-style-type: none"> <li>● Receiver volume is set too much?</li> </ul>	<ul style="list-style-type: none"> <li>● Turn down Receiver volume, and turn up other equipment volume.</li> </ul>
Noise out of microphone	<ul style="list-style-type: none"> <li>● Obstacle wave is disturbing?</li> <li>● Microphone wave power is set too week?</li> </ul>	<ul style="list-style-type: none"> <li>● Set another channel to leave away from obstacle wave creation.</li> <li>● Re-set microphone wave power.</li> </ul>

## SPECIFICATIONS

### RECEIVER

Type .....	Double Superheterodyne
AF Frequency .....	A: 610MHz - 639.7MHz (0-99 Ch) B: 640MHz - 669.7MHz (0 - 99 Ch)
Channel .....	200 Ch (0-99 Ch + 0-99 Ch)
Sensitivity .....	12 dB uV (80 dB S/N)
Distortion .....	0.5 %(Max)
Audio Output	
Balanced .....	300 mV - 2 V
A+B Output .....	10 mV - 2 V
Antenna Input .....	BNC Type (50 Ω)
Power Requirements .....	12V / 600mA
Operating Temperature .....	5°C - 40°C
Dimensions .....	211 (W) x 45 (H) x 160 (D) mm
Weight .....	0.8 Kg
AC Adapter	
Power Voltage .....	100V - 240V AC 50/60Hz
DC output Voltage .....	DC12V 1000mA

### MICROPHONE

AF Frequency .....	610MHz - 669.7MHz
Wave Type .....	F3
Radiated Output .....	10mW
Frequency Stability .....	±0.005%(Max)
Modulation .....	±45 KHz
Frequency Response .....	40 Hz - 18 KHz
Dinamic Range .....	100 dB
Microphone type .....	Dinamic type
Dimensions .....	Φ51 X 247 (H) mm
Weight .....	350g ( Include two batteries )

### Accessories

Owner's Manual .....	1
AC Adapter .....	1
Antenna .....	(1/2λ) 2
Connection Wire (With Φ6.5 Jack ) .....	1

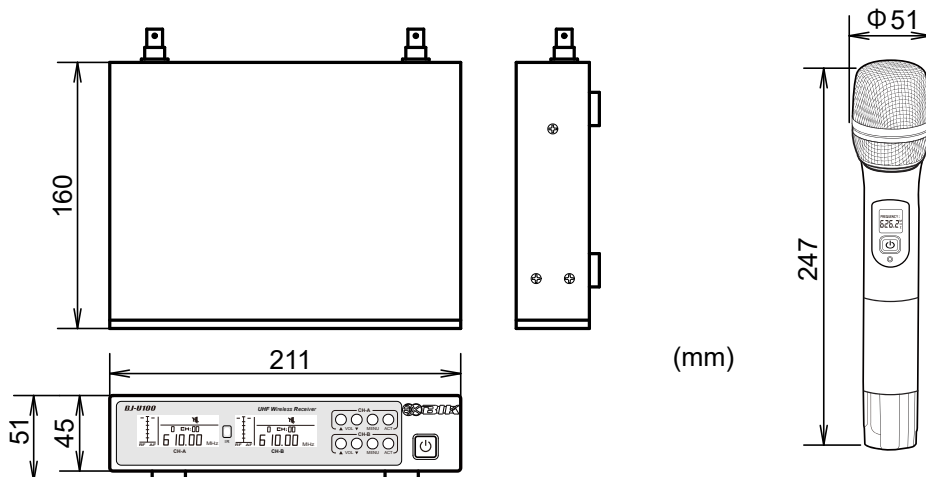

● Design and specifications subject to change without notice.



<b>目录</b>	安全注意事项 .....	5	操作方法 .....	6	产品规格 .....	7
	各部分的功能及名称 .....	5	设定方法 .....	6		
	连接方法 .....	6	故障分析处理 .....	7		

## 安全注意事项

安全注意事项是为了安全正确使用本商品、防止给自己及他人带来财产损失。  
以下用图标形式加以注明。请仔细阅读本文。

 <b>警告</b>	<b>警告</b> 无视或误用会有造成人身事故的可能性。
 <b>注意</b>	<b>注意</b> 无视或误用会有造成人身伤残、或对财产损坏的可能性。

### 警告

- 在使用时、如果有冒烟、异味、异音等异常现象发生、为避免发生火灾、触电现象等、请立即切断本机电源、然后拔下AC电源插头。确认没有再冒烟后、到贩卖店进行修理。
- 在使用时如有水或异物等混入机体内、首先切断机体电源、然后拔下AC电源插头。请尽快与经销商联系、进行修理。
- 在未进行维修的状态下使用、会引起火灾、触电现象等问题。
- 请勿分解、改装本机器、会引起火灾、触电、故障等现象。绝对不可以打开本机器的外壳、会引起触电事故。内部的检查、修理等请委托经销商。
- 请勿在浴室内使用、会引起火灾、触电等现象。
- 请防止机器进水或使机器受潮、会引起火灾、触电等现象。
- AC电源插头不要插入电压（AC100V - AC240V）以外的电源上。有造成火灾、触电的危险。
- 一定要使用本机附属品AC插头。使用其他电源插头会有造成机器故障的可能。
- 请不要用带有灰尘、或带有湿气的插头和插座、会引起火灾等现象。

### 注意

- 旅行等长时间不使用时、为了安全请务必拔下插头。
- 如近距离内有雷电现象时、请拔下电源插头，由于雷电原因，会引起火灾、触电、故障等现象。
- 移动时首先关闭电源开关、然后务必拔下电源插头。
- 请勿放置在灶台、加湿器及有油烟、雾气的地方。会引起火灾、触电等现象。
- 请勿放置在不安稳的桌上、或倾斜的地方。会容易掉落、翻倒而造成损坏、损伤等现象。
- 请勿放置在紧闭车窗的汽车内、或阳光直射及高温的地方。以免造成零部件的损坏、而引起火灾。

## 各部分的功能及名称

### 前面板

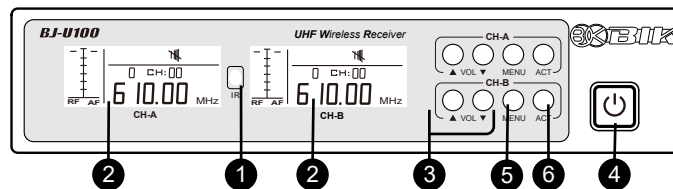

- 1** 红外线对频“IR”  
与麦克风的红外线窗口相对，将会自动设定频道。
- 2** 显示屏
- 3** 音量调节按钮、频率调节按钮
- 4** 电源开关
- 5** MENU 按钮  
MENU按键长按3秒（解锁）  
按VOL按键“▲、▼”设定频道  
MENU按键长按3秒（锁定）
- 6** ACT 按钮  
麦克风自动连接

### 后背板

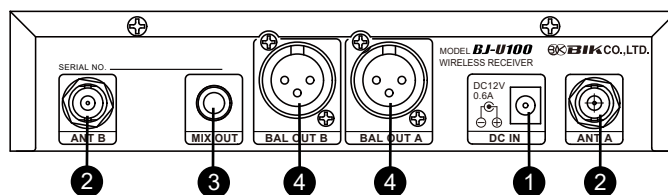

- 1** 连接DC12V电源插口
- 2** 天线连接插口
- 3** MIC A, MIC B音频混合输出
- 4** MIC A, MIC B音频输出插口（XLR型插座）

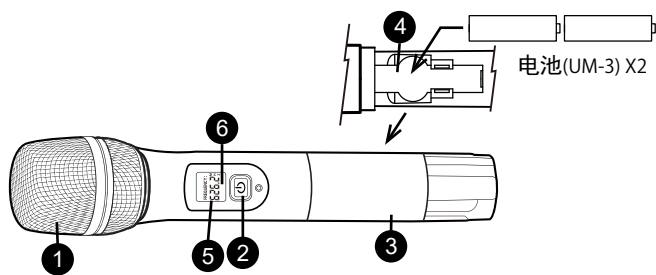

- ① 网头及音头模组
- ② 电源开关
- ③ 麦克风管体
- ④ 电池窗 2节 (UM-3) 电池
- ⑤ 显示屏
- ⑥ 红外线对频窗口 “IR”

### 连接方法

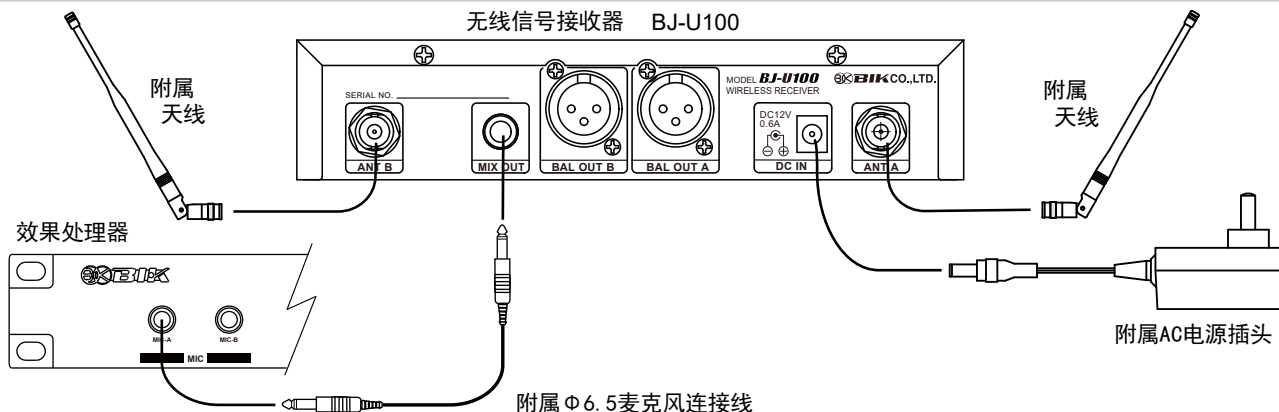

### 操作方法

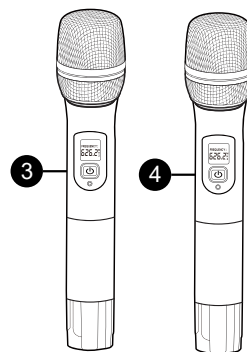
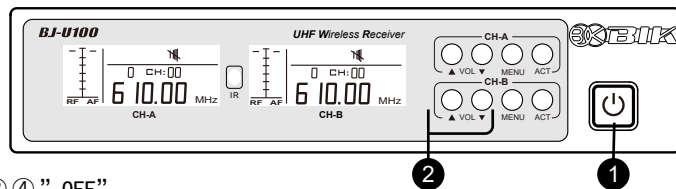

1. 将麦克风开关③,④,“OFF”
2. 接收器的电源开关“ON”
3. 麦克风开关“ON”
4. 转动旋钮②,调节音量

#### ※注意

出厂时完成接收器与麦克风的频道设定。  
接收器电源开关ON的时候,如果显示屏左右有RF信号显示的现象,说明周围有干扰信号。  
这种情况下请变更频道。\*请参照设定方法。

### 设定方法

#### 1. 频道设定方法

MENU按键长按3秒(解锁)  
按VOL按键“▲、▼”设定频道  
MENU按键长按3秒(锁定)

#### 2. 麦克风设定方法

1. 打开发射机电池盖,露出红外(IR)端口。
2. 将红外端口朝向接收机,然后从接收机液晶屏界面选择Sync(同步)>Sync(发送)。接收机上的显示屏将显示是否同步成功。如果同步失败,请再次尝试操作,并确保已将发射机上的红外端口暴露在外,并直接对准接收机的红外端口。  
注释:在另一台接收机上执行同步之前,应关闭电池仓门。

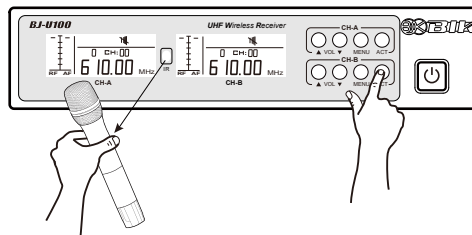

## 故障分析处理

如感觉有故障请根据以下方法检查。偶尔会有因为操作错误而误认为是故障的现象。根据以下方法检查也不能解决的情况下，请直接联系代理经销商

故障症状	原因	解决方法
没有电源输入	<ul style="list-style-type: none"> <li>● AC电源插头没有完全插入插座</li> <li>● AC电源插头与接收器没有完全连接好。</li> </ul>	<ul style="list-style-type: none"> <li>● 将AC电源插头完全插入插座。</li> <li>● 修正AC电源插头与接收器之间的连接。</li> </ul>
麦克风开关没有反应	<ul style="list-style-type: none"> <li>● 电池没有电</li> </ul>	<ul style="list-style-type: none"> <li>● 更换电池</li> </ul>
有电源输入但是没有声音	<ul style="list-style-type: none"> <li>● 接收器与其他周边设备的连接方法不正确。</li> <li>● 接收器的音量旋钮是最小状态。</li> <li>● 周边设备的音量旋钮是最小状态。</li> <li>● 接收器和麦克风的频道不同。</li> </ul>	<ul style="list-style-type: none"> <li>● 确认连接部分</li> <li>● 打开接收器的旋钮</li> <li>● 打开周边设备的旋钮</li> <li>● 设定频道。</li> </ul>
破音	<ul style="list-style-type: none"> <li>● 接收器的音量旋钮打的过大。</li> </ul>	<ul style="list-style-type: none"> <li>● 接收器的旋钮减小，连接的周边设备旋钮打大。</li> </ul>
麦克风有杂音	<ul style="list-style-type: none"> <li>● 可能受干扰信号的影响。</li> <li>● 可能是麦克风的信号强度设定过小。</li> </ul>	<ul style="list-style-type: none"> <li>● 变更为没有干扰信号的频道</li> <li>● 重新设定麦克风的信号强度。</li> </ul>

## 产品规格

### 接收器

接收类型	二次变频超外差
接收频率范围	A: 610MHz - 639.7MHz (0-99 Ch) B: 640MHz - 669.7MHz (0 - 99 Ch)
频道数	200 Ch (0-99 Ch + 0-99 Ch)
灵敏度	12 dB uV (80 dB S/N)
失真度	0.5 % (Max)
音频输出	
平衡输出	300 mV - 2 V
混合输出	10 mV - 2 V
天线接口	BNC (50 Ω)
电源需求	12V / 600mA
工作温度	5°C - 40°C
规格尺寸	211(长) x 45(高) x 160(宽) mm
重量	0.8 Kg
电源适配器	
输入电压	100V - 240V AC 50/60Hz
输出电压	DC12V 1000mA

### 麦克风 **BJ-M100**

发射频率	610MHz - 669.7MHz
波型	F3
发射功率	10mW
频率稳定度	±0.005% 以内
最大频偏	±45 KHz
频率响应	40 Hz - 18 KHz
动态范围	100 dB
麦克风类型	动圈式
尺寸	Φ51 X 247 (H) mm
重量	350 g (包含两节电池)
附件	
使用手册	1
电源适配器	1
天线	(1/2 λ) 2
连接线 (Φ6.5 接头)	1

● 设计和规格如有变更，恕不另行通知。

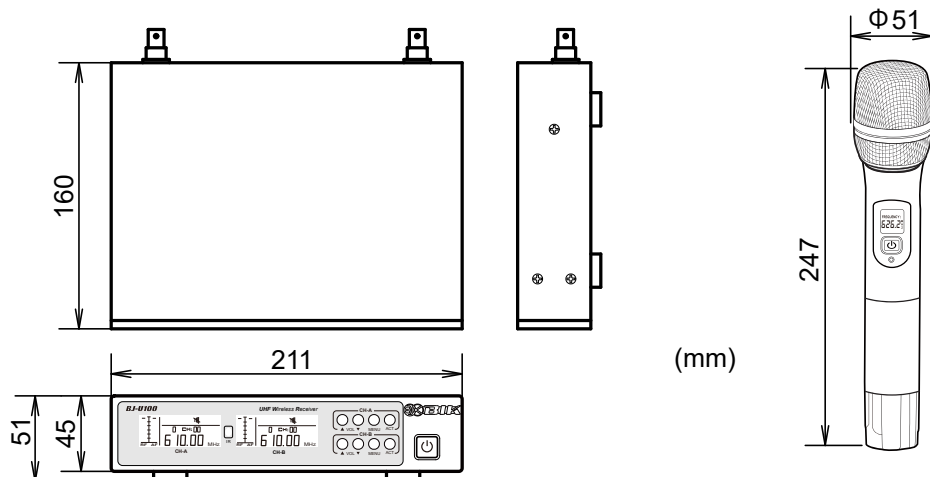



---

株式会社 ビーアイケー  
〒343-0856 埼玉県越谷市谷中町3丁目17-1

**BIK CO.,LTD.**  
3-17-1 YANAKA-CHO. KOSHIGAYA-SHI. SAITAMA-KEN. 343-0856 JAPAN  
TEL. +81-48-969-6533 FAX. +81-48-969-6556  
URL. <http://www.bik-audio.com> Email. [best-sound@bik-coltd.jp](mailto:best-sound@bik-coltd.jp)